

XLO



WORK SERIES

XLO



OPTIONALS

- 2108544 METAL BOX (ONLY XLO-90)
- FU-P COVERS
- MI-04A WIRELESS REMOTE CONTROL
- 2108541 CONTROL PUSHBUTTON WITH 3m CABLE

	220-240V (50-60 Hz)
	60 W
	OK

	30 L/min
	0° - 60° - 90°
	OK - BATTERY 12V
	OK

XLO-90-2

	300 kg
	90 kg
	24 kg

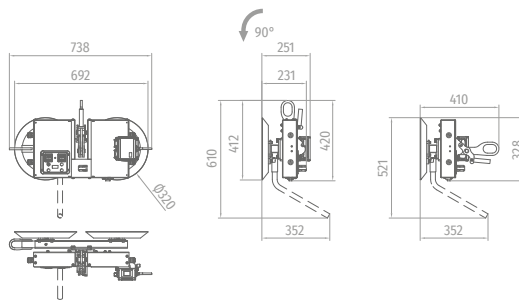

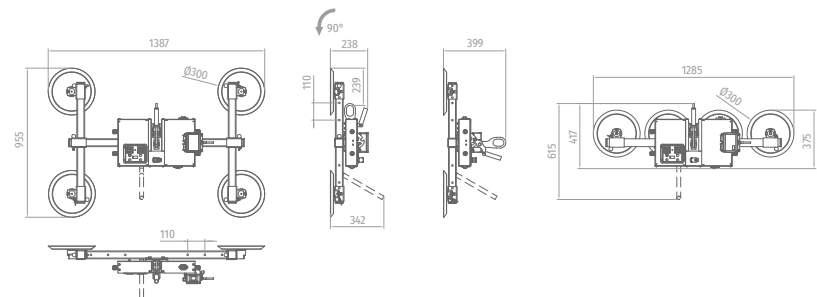

XLO-300-2

	600 kg
	300 kg
	49 kg



XLO-90-1

	300 kg
	90 kg
	23 kg

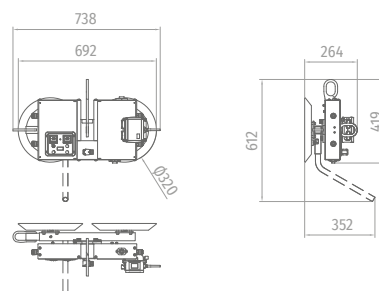

XLO-300-1

	600 kg
	300 kg
	48 kg

